



# USER MANUAL

## A3716, A3800 Online Monitoring System



# Content:

<b>Basic hardware explanatory notes .....</b>	<b>4</b>
The Adash DSP board .....	4
4-20mA current loops and its industrial use .....	4
Relay outputs.....	4
Latched relay .....	4
<b>A3716 unit description .....</b>	<b>6</b>
A3716 - Front panel .....	6
A3716 - Rear panel.....	7
<b>A3716 sensor and tacho connection .....</b>	<b>9</b>
Acceleration sensor connection .....	9
Tacho trigger (speed probe) connection.....	9
<b>A3800 unit description .....</b>	<b>10</b>
A3800 - Front panel .....	10
A3800 - Bottom panel .....	11
<b>A3800 sensor and tacho connection .....</b>	<b>12</b>
A3800 – Top panel .....	12
Acceleration sensor connection .....	13
Tacho trigger (speed probe) connection.....	13
<b>A3764 – 64 channel multiplexer .....</b>	<b>14</b>
Front panel .....	14
Rear panel .....	15
Wiring scheme.....	16
Technical Specification .....	16
ICP powering .....	16
<b>A3716 IP address setting (the same for the A3800).....</b>	<b>17</b>
A3716 (A3800) as a stand alone computer .....	17
Network remote access .....	18
IP address setting .....	18
<b>Network for data transfer (the same for the A3800) .....</b>	<b>20</b>
Company network usage .....	20
Creating of your own network .....	20
Connection test.....	21
<b>Server software installation (the same for the A3800) .....</b>	<b>22</b>
Adash Server installation .....	23
<b>DDS – online database and collecting of readings (the same for the A3800) ...</b>	<b>26</b>
Online database creation .....	26
Measuring unit and database connection.....	26
Start of the data collection .....	27
Graph refresh time interval.....	28
Actual data reading.....	29
Current loops and relays.....	29
Conditional measurements .....	30
Temporary stop of readings .....	30
Advanced functions for A3716 (A3800) units .....	31
A3716 (A3800) lock .....	32
Updating DDS.....	32
<b>Adaptive algorithm for readings .....</b>	<b>33</b>
How does the algorithm work? .....	33

Large dynamic readings processing.....	33
Data saving example .....	33
<b>Variable settings of data collection .....</b>	<b>35</b>
Regulator section.....	35
Examples.....	36
<b>Time synchronization of A3716 (A3800).....</b>	<b>37</b>
<b>A3716 (A3800) Update.....</b>	<b>38</b>

## **Basic hardware explanatory notes**

We would like to explain a few terms in the beginning of this manual.

### **The Adash DSP board**

The Adash DSP (Digital Signal Processing) board is the most important part of the instrument. The special chip provides all necessary operations, which are required for achieving of 4 channel synchronous data.

### **4-20mA current loops and its industrial use**

For industrial process control instruments, analog 4–20 mA current loops are commonly used for analog signaling, with 4 mA representing the lowest end of the range and 20 mA the highest. The key advantages of the current loop are that the accuracy of the signal is not affected by voltage drop in the interconnecting wiring, and that the loop can supply operating power to the device. Current loop outputs of actual value are then used in control systems (PLC).

The current loops used in the A3716 are isolated from measuring circuits. They must be externally powered (they use passive mode).

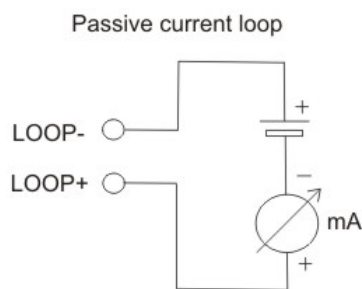

### **Relay outputs**

Two relay initial states exist. Energized and de-energized. Energized relay is initially powered and its internal connections are as seen on the picture below (NO-normally opened, NC-normally closed, COM-common are standard electrical terms). De-energized relay is initially not powered. Internal connections are seen on the pictures.



### **Latched relay**

We describe it on example:

The factory initial state of the relay is de-energized (i.e. NC and COM is connected). The ISO RMS (10-1000Hz) value is measured on the machine. When the RMS value will exceed 2 mm/s, then the relay will switch on the red light in a control room. When the vibration value will decrease under the 2mm/s, then the relay will switch off the light.

If the LATCH function is chosen, then the relay will not switch off the light when the vibration decreases less than 2mm/s. The relay keeps the switch ON until it is manually switched off ( through the use of REL-RST).

## A3716 unit description

### A3716 - Front panel

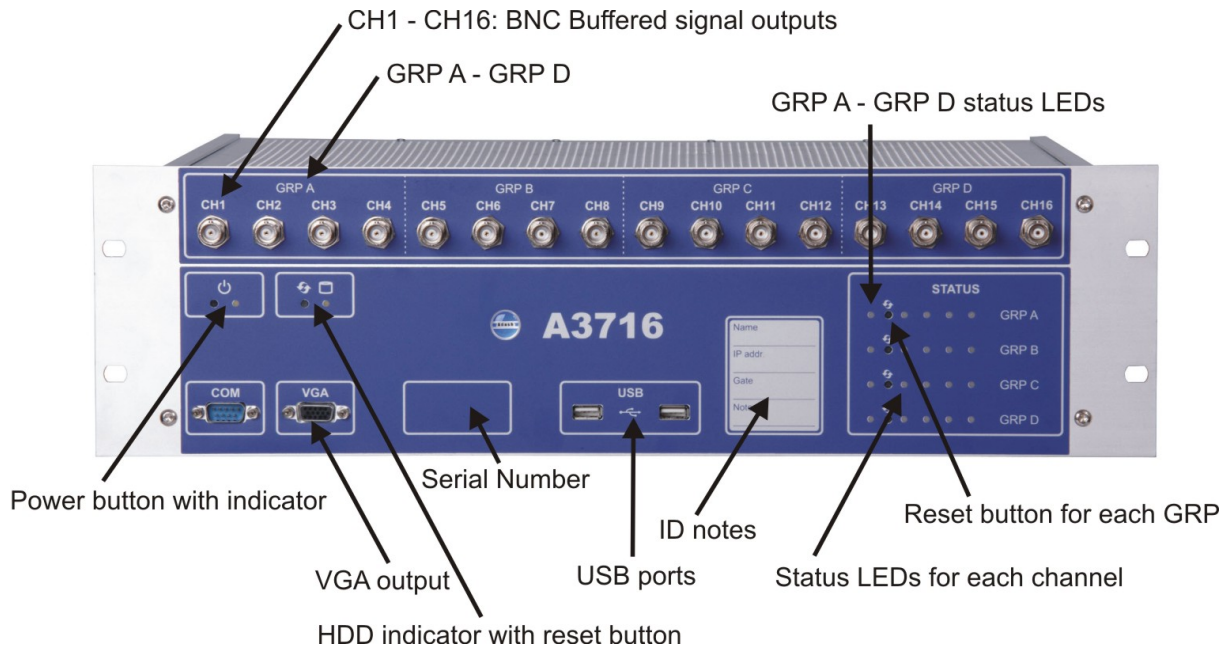

#### Legend:

**CH1 - CH16 BNC buffered outputs** (A3716/3U only) allows connecting of portable vibration analyzer and performing further analysis on required channel.

**GRP A – GRP D.** 16 channels are divided into 4 groups A,B,C,D. Each of them contains 4 channels, which are measured by one Adash DSP 4channel board.

**GRP A – GRP D status LEDs** enables to monitor each DSP board. Three states can appear:

- **OK, the measurement is running** - green light blinks in 0.25sec time interval (four times per sec)
- **OK-STANDBY, the measurement is stopped** - green light blinks in 1 sec time interval
- **ERROR** - red light.

**Reset button** enables to reset each Adash DSP board ( A,B,C,D).

**Power button** runs the A3716 unit. There is a status LED as well.

**VGA output** allows connecting of monitor in case you use the A3716 as a 16 channel vibration analyzer.

**HDD status LED** indicates the operation state of the hard drive.

**Serial number** of the A3716/3U is 6 digits number provided by Adash. If more A3716 unit is used, it helps to recognize them in setting.

**USB ports** allows connecting of mouse and keyboard for control of the A3716 unit in case you use the A3716 as a 16 channel vibration analyzer the USB ports.

**Status LEDs** for each channel informs about the operation state of appropriate channel. Green color indicates good condition of the channel input, sensor and cable. Red color indicates error. In this case you should check the sensor and cable. Otherwise contact your supplier of A3716 unit.

### A3716 - Rear panel

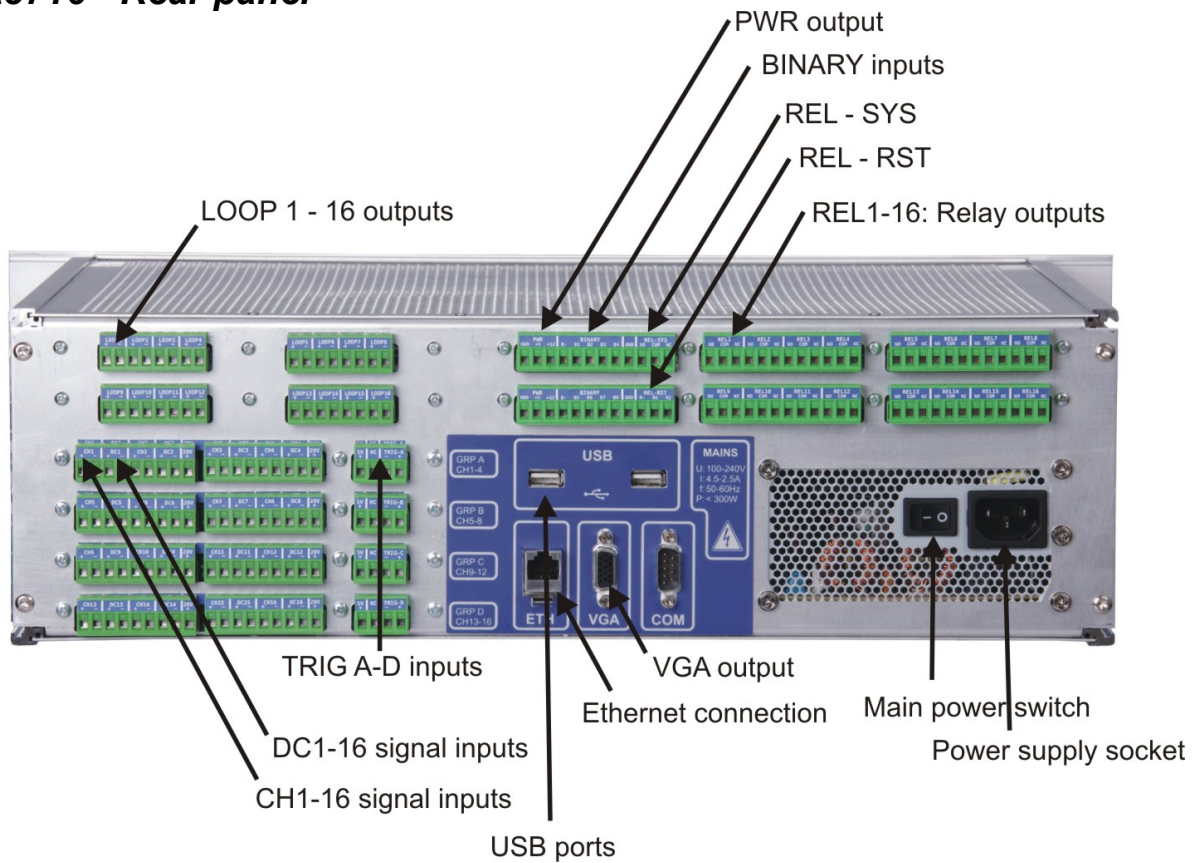

**Legend:**

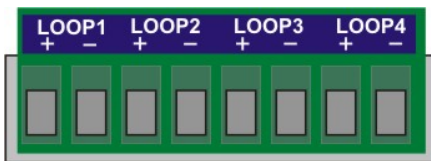

**LOOP 1-16 outputs** (A3716/3U only) contains 4 – 20 mA current outputs clamps.

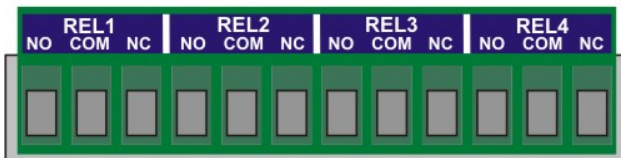

**REL 1-16 Relay outputs** (A3716/3U only) contains relay clamps (NO,COM,NC).

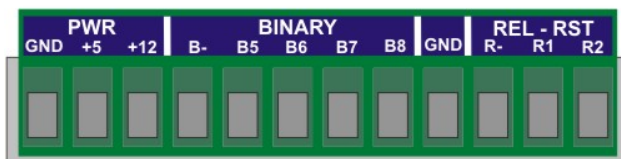
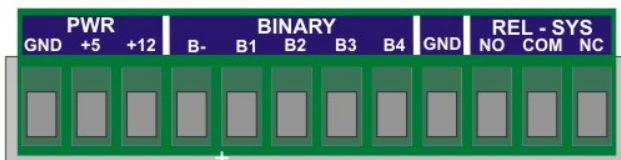

**PWR output** (A3716/3U only) is the source of +5V/1A and +12V/1A voltage outputs. All GND (grounds) clamps are shorted (connected together).

**BINARY inputs** (A3716/3U only) are logical inputs ( states 0 or 1)  
 B- Common negative pole

B1...B8 – Isolated inputs 5-30V/4mA max. The level of voltage on each input defines the logical state.

**Logical 0** - DC voltage 0-3V is required

**Logical 1** - DC voltage 5-30V is required.

You should avoid the voltage in 3-5V range. The response of the circuit is unclear and unpredictable. It may oscillate and accidentally change logical values.

**REL - SYS** - if the A3716 system is in correct operation then this system relay is energized (A3716/3U only). In case of DSP board error or ICP error relay is deenergized.

**REL - RST** resets all latched relays (A3716/3U only).

R-: Common negative pole

R1 and R2: (DC voltage 5-30V/4mA max.)

When the voltage appears on R-R1 or R-R2 then all latched relays will be reset. You may have a question: why two clamps are used (R1 and R2)? It enables to reset latched relays by two buttons which could be in two places. E.g. one reset button is near of the A3716 and second reset button is in the control room.

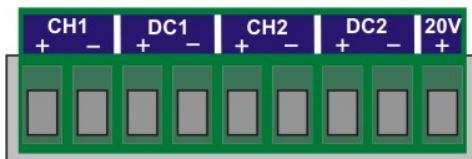

**CH 1 – 16** AC inputs (ICP® powering available) for AC signals measurement, usually for vibration measurements (acceleration sensor connected). Max. Peak/Peak voltage range is +/- 12 V.

**DC 1 – 16** DC inputs for DC signal measurement (e.g. process values like temperature, pressure, flow etc.). Max. voltage range is +/- 24V.

**20V output**, max. 10mA. It is available for external powering of sensors. Use the minus pole from the appropriate input.

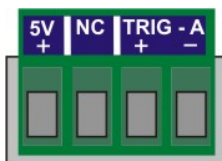

**TRIG A-D inputs** are for trigger connection for GRP A-D (see front panel description).

+5V: power for tachometer (speed) probe (max 100 mA)

NC: not connected

-: ground

+: trigger signal input

**VGA output** allows connecting monitor in case you use the A3716 as a 16 channel vibration analyzer. It is shorted with the same output on the front panel.

**USB ports** allow connecting mouse and keyboard for control of the A3716 unit in case you use the A3716 as a 16 channel vibration analyzer the USB ports. They are shorted with the USB ports on the front panel.

**Ethernet** connection to LAN for setting and data transfer.

**Main power switch** for switch on/off of the A3716 unit.

**Power supply socket** requirements:

U: 100-240 V

I: 2,5-4,5A

f: 50-60 Hz



## **A3716 sensor and tacho connection**

### **Acceleration sensor connection**

Commonly used sensor is the acceleration sensor 100 mV/g with ICP®.

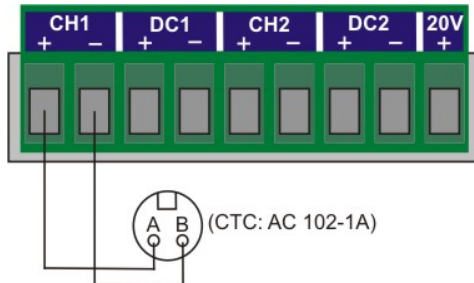

### **Tacho trigger (speed probe) connection**

Tacho trigger input range is + 10V.

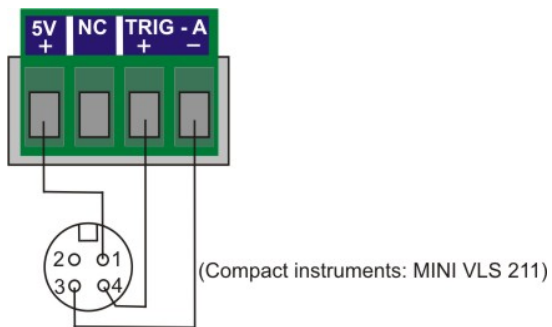

## A3800 unit description

### A3800 - Front panel

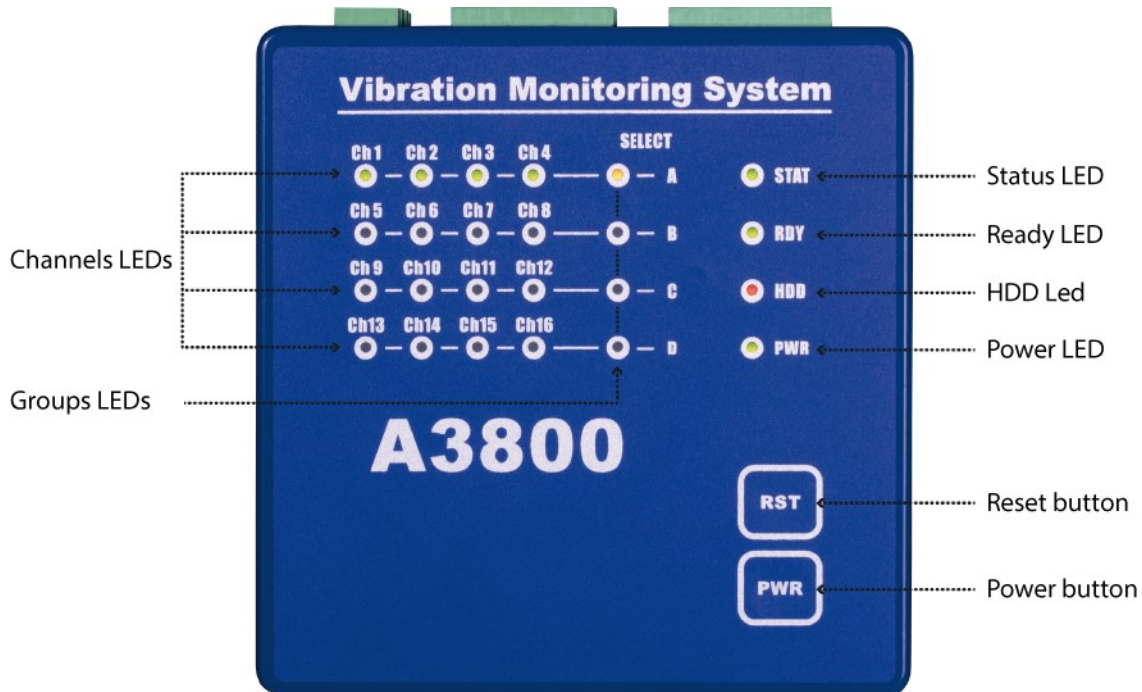

#### Legend:

**Channels LEDs** indicate on which channels the measurement is defined.

Green color ... indicates good condition of the channel input, sensor and cable.

Flashing red color ... indicates sensor or cable error.

**Groups LEDs** indicate which channel group is active for measurement.

Orange color ... indicates active group.

**Status LED** indicates status of A3800 DSP board.

Fast flashing green color (four times per sec) ... measurement is running.

Slow flashing green color (one time per sec) ... waiting for measurement

Red color ... DSP board error.

**Ready LED** indicates status of A3800 control board.

Green color ... control board OK.

Red color ... control board error.

**HDD LED** indicates r/w operation on HDD.

Red color ... r/w operation in progress.

**Power LED** indicates power on of A3800 unit.

Green color ... A3800 unit is power on.

**Reset button** ... press and hold for at least 5 seconds to reset control board.

**Power button** ... press and hold for at least 5 seconds to switch ON/OFF A3800 unit.

### ***A3800 - Bottom panel***



**Legend:**

**AUDIO I/O:** socked for audio 3.5 jack.

**USB 2.0:** two USB ports.

**ETHERNET:** socked for Ethernet connection.

**DISPLAY:** HDMI display connection

**POWER:** socked for 12 V DC powering

## A3800 sensor and tacho connection

### A3800 – Top panel

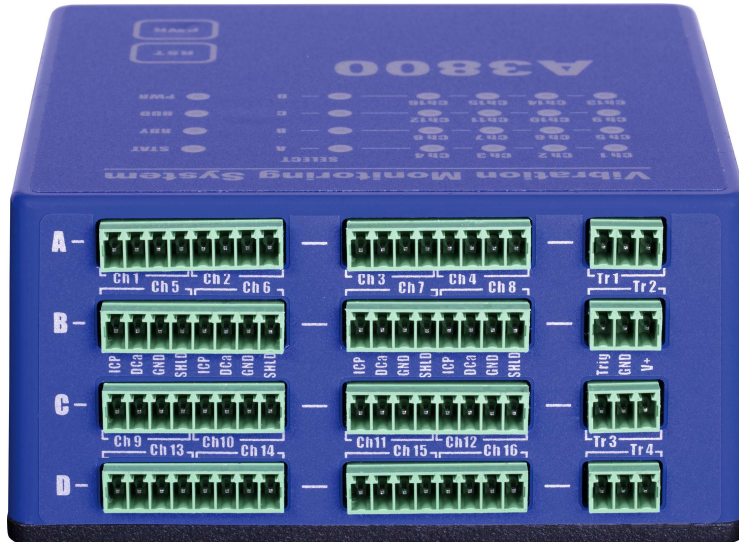

The connectors for connecting the sensors are located on the top panel. Connectors are divided into groups A, B, C, D.

**Group A:** AC and DC channels 1 – 4, TACHO input 1.

**Group B:** AC and DC channels 5 – 8, TACHO input 2.

**Group C:** AC and DC channels 9 – 12, TACHO input 3.

**Group D:** AC and DC channels 13 – 16, TACHO input 4.

#### Input ranges:

AC input: +/- 12 V peak - peak

DC input: +/- 24 V or 4 – 20 mA

TACHO +10 V

In this picture you can see top panel with installed plug-ins.

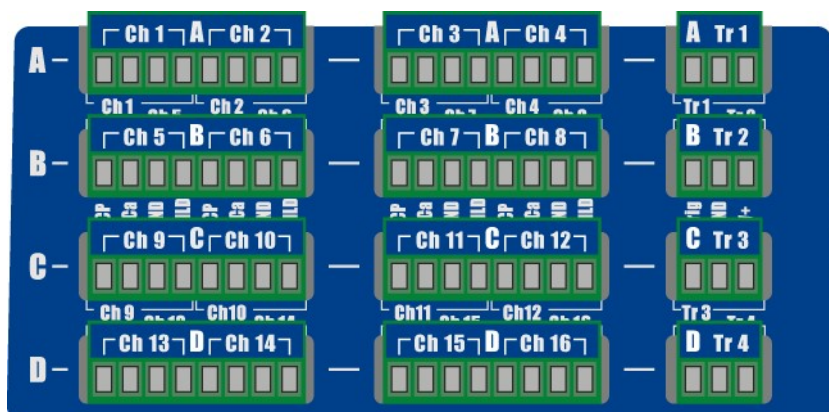

## Acceleration sensor connection

Commonly used sensor is the acceleration sensor 100 mV/g with ICP®.

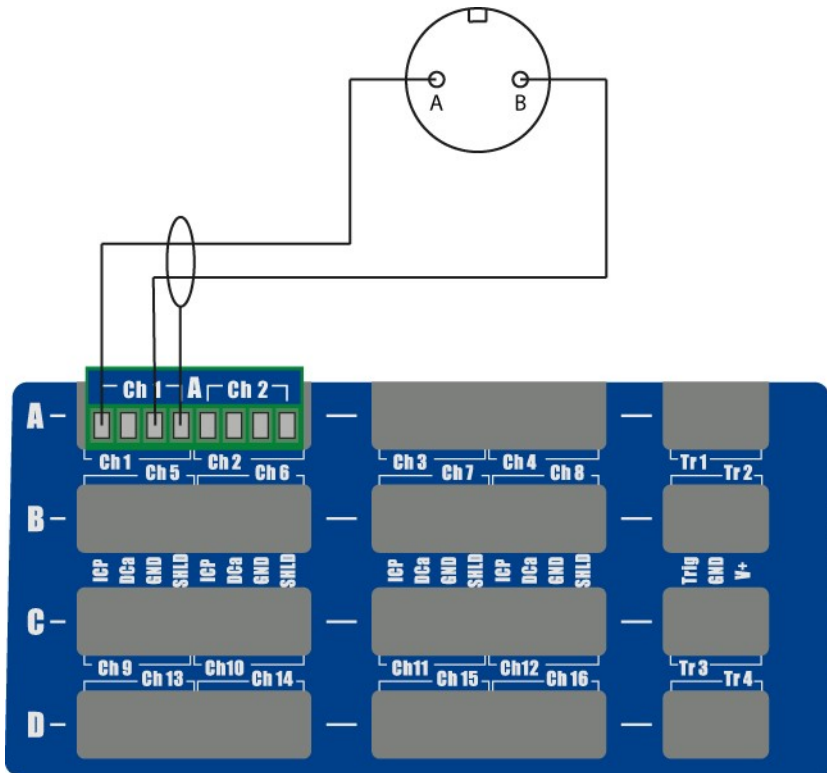

## Tacho trigger (speed probe) connection

Tacho trigger input range is + 10V.

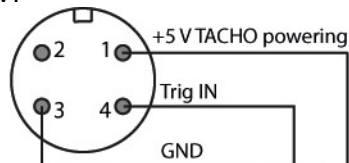

TACHO: Compact Instruments MINI VLS 211

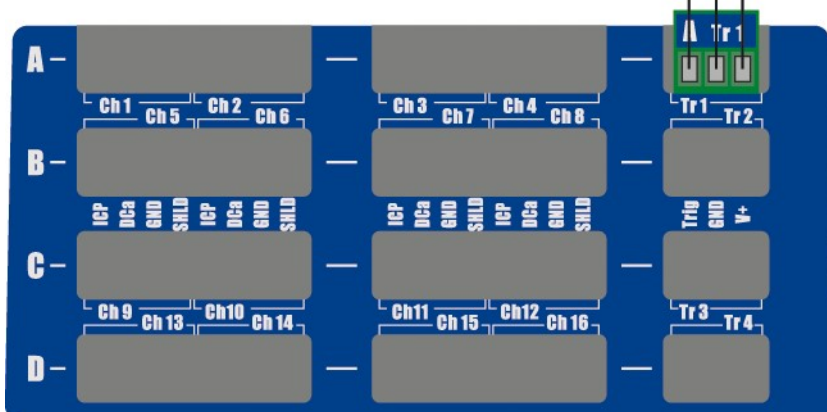

# A3764 – 64 channel multiplexer

A3764 multiplexer enables to use 64 AC channels. They are not synchronous. They are divided to 4 groups, each of them has 16 synchronous channels. These 4 groups are continuously switched (multiplexed) to AC inputs and then the measurements are taken.

The A3716 and A3764 are connected by 16 signal wires and a the USB cable is used for transfer of control signals.

**Warning!** The A3764 unit doesn't multiplex DC channels neither tacho inputs. It means the 16 DC inputs and 4 tacho inputs are available for all 64 AC channels.

## Front panel

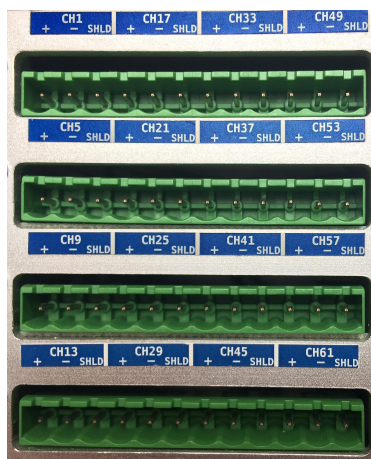
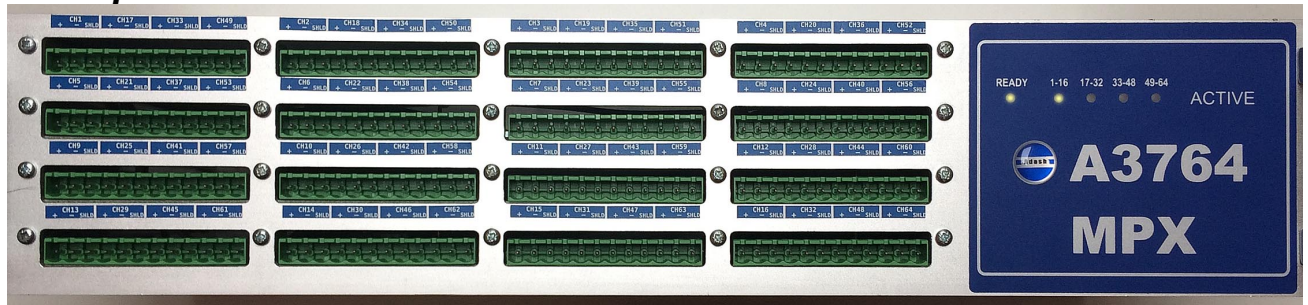

The terminal blocks for wire connection and LED diodes are on the front panel.

LED description:

READY

1-16, 17-32, 33-48, 49-64

connected to A3716 (communication established)

actually measured group

Terminal block view, channel order:

1	17	33	49	2	18	34	50	3	19	35	51	4	20	36	52
5	21	37	53	6	22	38	54	7	23	39	55	8	24	40	56
9	25	41	57	10	26	42	58	11	27	43	59	12	28	44	60
13	29	45	61	14	30	46	62	15	31	47	63	16	32	48	64

**Rear panel**

The rear panel contains

- output terminals for signals (OUT1 – OUT16),
- USB B connector for communication,
- terminal for powering of external equipments (+24V, +5V)
- EURO socket with fuse for power supply.

## Wiring scheme

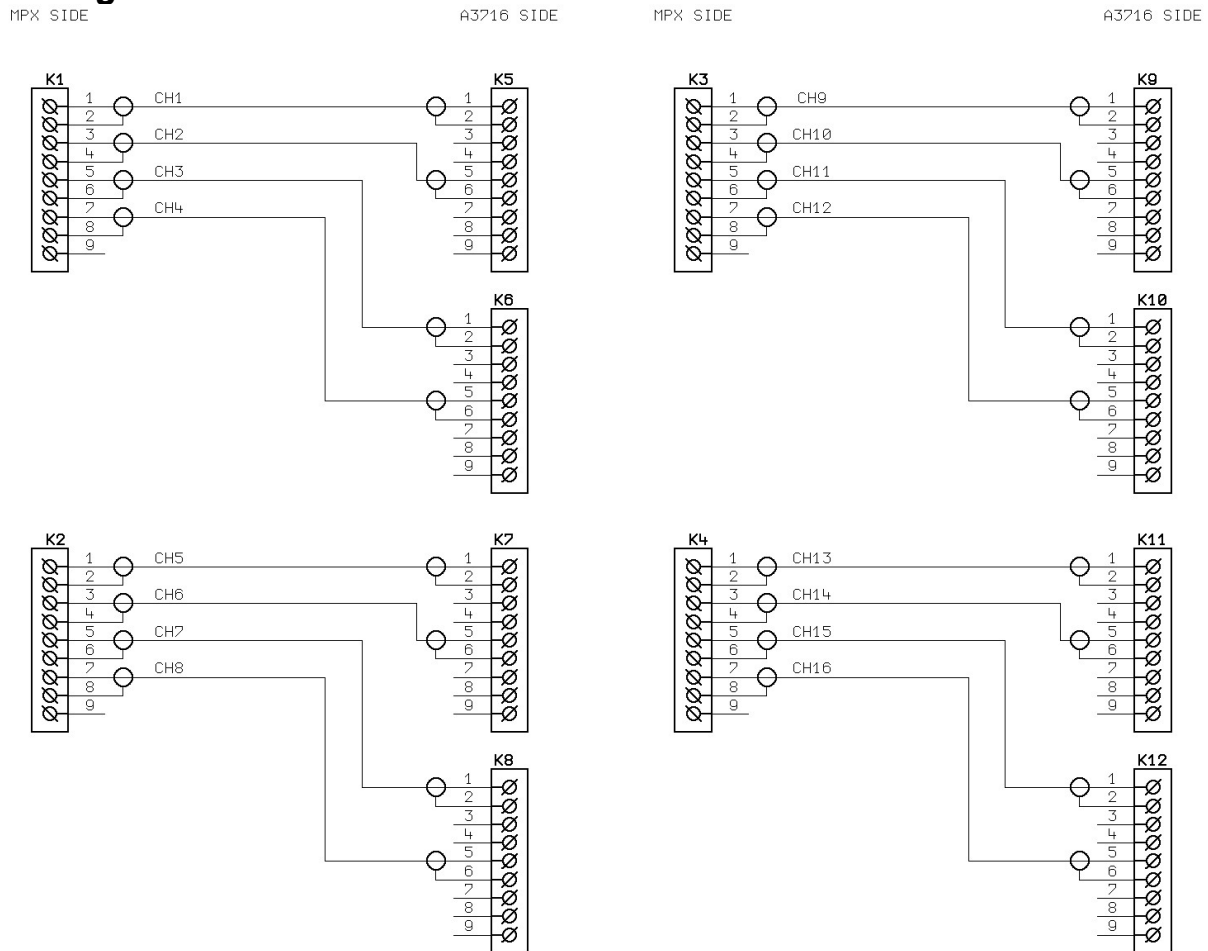

K1 – K4: Terminal blocks on A3764 side (MPX)  
 K5 – K12: Terminal blocks on A3716 side

## Technical Specification

Powering: 85-265V AC / max 15W, protection 0.5A  
 Communication: USB  
 Inputs: 16x4 (64) with ICP powering 24V / 4mA  
 Outputs: 24V/300mA, 5V/100mA, 16x AC signal output

## ICP powering

The A3764 unit contains own ICP power supplying. It means the ICP is not switched from A3716 unit. All sensors are continuously powered and no additional settling time is required. All sensors connected to A3764 inputs are always powered. It is not possible to power only some of them. Unfortunately there's no way how to indicate an ICP error.

Optionally you can have an A3764 unit without ICP power supply. If you wish using sensors without ICP, please specify the demand in your order.



## **A3716 IP address setting (the same for the A3800)**

A3716 rack basically behaves as a local PC and it has its own IP address under which it is recognized in your network. Most common situation is that you will need to change the A3716 rack IP address because of your company's policy.

Remark: If you don't need to change the rack IP address, skip to chapter: **Network for data transfer**

There are two ways how the setup the IP address.

### **A3716 (A3800) as a stand alone computer**

Windows OS is installed on A3716 measurement unit, so it is possible to connect with it like to a common PC. Connect USB keyboard, mouse and monitor (VGA interface or HDMI interface). In Windows login as a "remote" user with "remote" password and follow the chapter IP address setting.

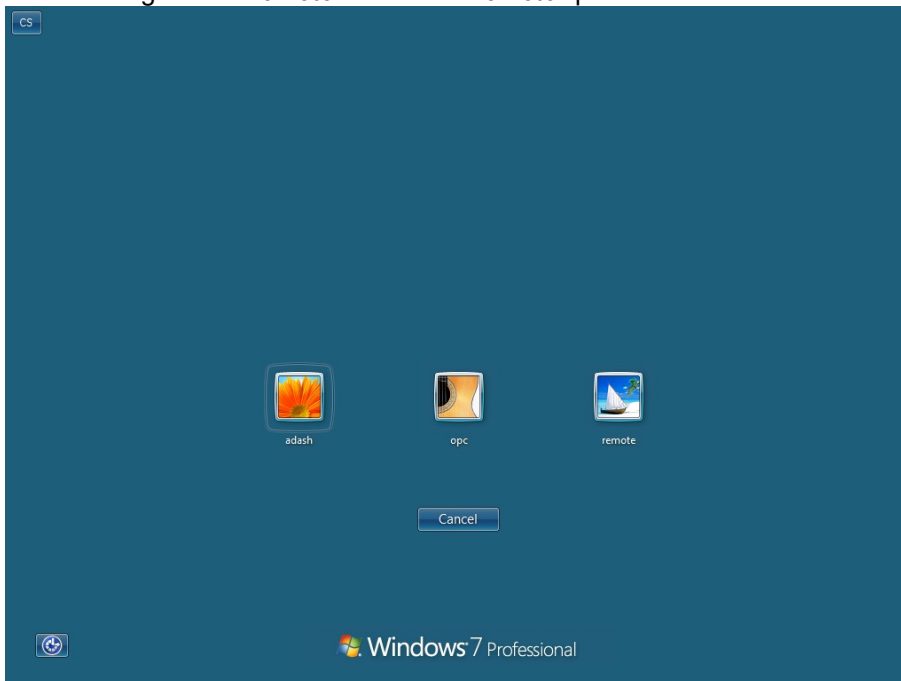



## Network remote access

Second option how to change the A3716 IP address is to do it through network. Use the LAN cable and connect the A3716 unit with PC (laptop) directly or through network (switch/HUB). IP address (set during production) is written on the A3716 front panel. Use this IP address for remote desktop connection. You can also use name of the unit, which is „A3716 – serial number“.

## Remote desktop connection

**Remote desktop connection** is a program which allows to control another PC on the network from your PC. From any PC on the network you can connect A3716 and change its setting (e.g. IP address). Remote desktop program is a standard part of the Windows OS. You can find it under Start button in Accessories folder.

It can be run also by "Search programs and files" in Start menu (Win7). Enter "*mstsc*" and press enter. You can launch it also from "Run" window (press Win  + R). Enter "*mstsc*" and press Enter. New window **Remote desktop connection** appears then.

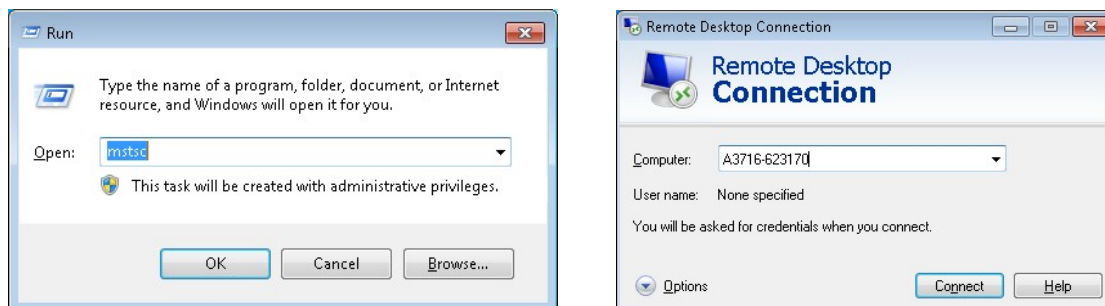

Enter the IP address or name of the computer into the **Computer** line and press *Connect*. Enter log in parameters (factory settings are **remote** for username and password).

## IP address setting

Press Win  + R, enter "*ncpa.cpl*" and press Enter

Network connection window will open. Select network adapter (usually *Local area connection*) press right mouse button and select *Properties*.

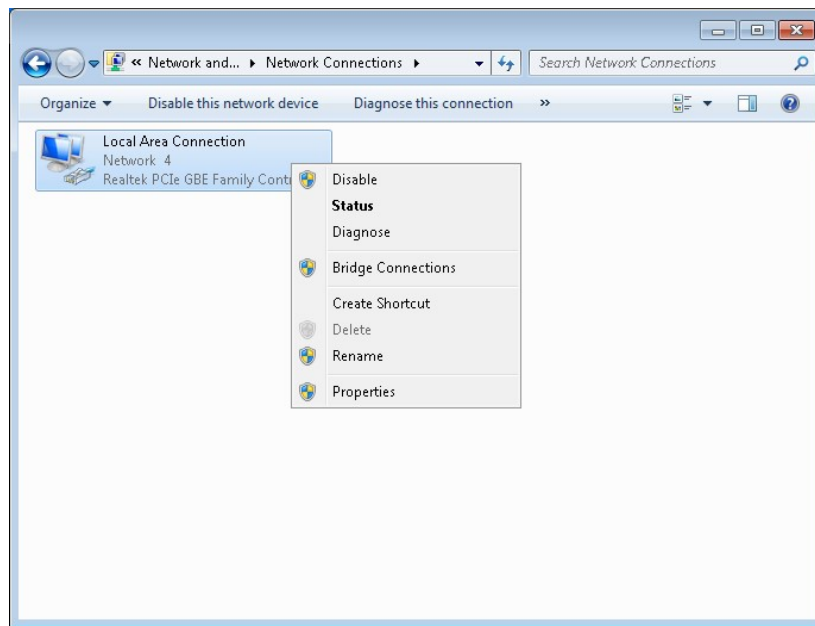

Select "networks" tab in "This connection uses the following items" section. Select "Protocol IP version 4 (TCP/IPv4)" and press „Properties“. Select "General" tab and check the option "Use the following IP address". Enter the address which your network manager gave you.

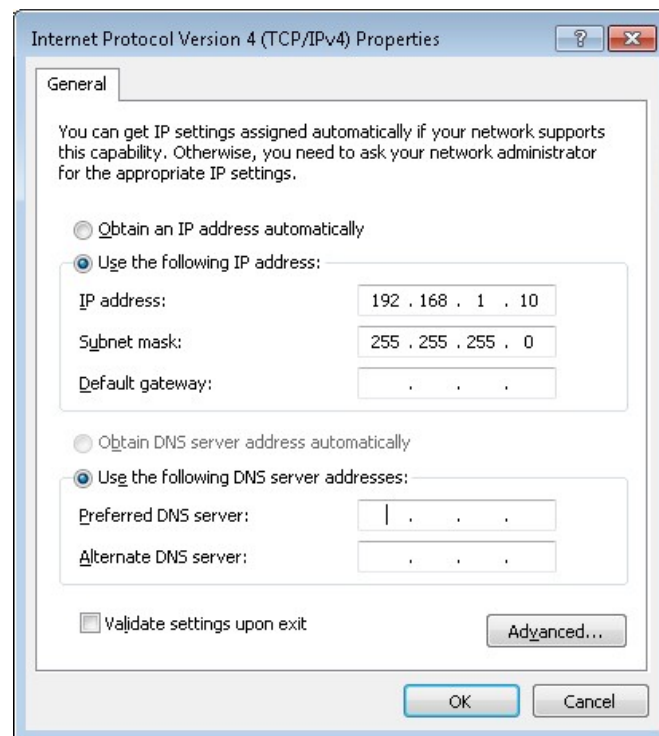

If you are changing the IP address using remote desktop, then after this change you have to create the new connection ( connection with and old IP address will stop working).

## **Network for data transfer (the same for the A3800)**

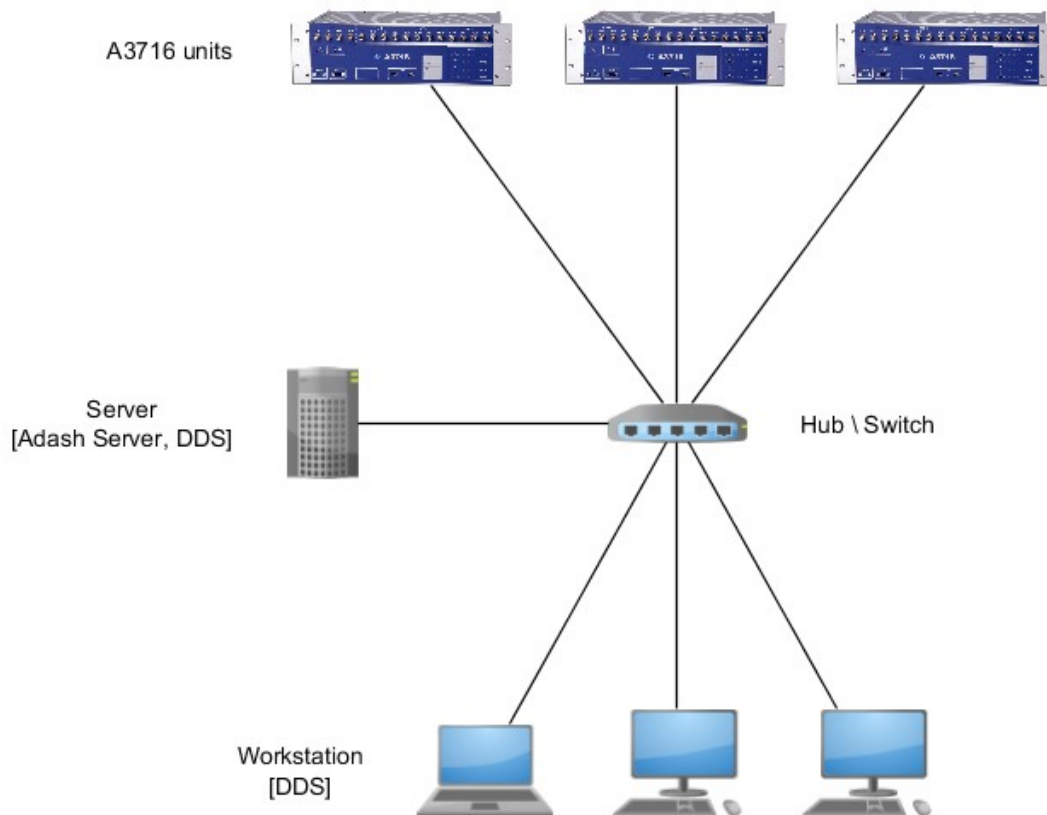

Server ( computer ):

- Determined for data collection and storage
- Ideally stand alone computer which is not used for any other purposes
- Continuous operation – pay attention on a proper components selection
- Connect ideally Gbit network with A3716 with DDS computer
- Suitable size of RAM and HDD

Software on a Server:

- Windows OS on the server
- DDS for tree management / data collection
- Program Data Manager as a service which handles data

### ***Company network usage***

In case of using company network, you need to assign static IP addresses to all components (measuring units, server, users stations). We recommend to do it in cooperation with IT department.

### ***Creating of your own network***

If you decide to build your own computer network, then follow the following procedure. We always recommend to create a network with cables, not wireless.

## Connection test

Use "ping" program (part of the Windows OS)

Launch command line press Win  + R enter "cmd" and press Enter.

The cmd.exe. window appears.

Enter command "ping" with the computer IP address whit which you want to test the transfer speed (e.g. ping 192.168.1.124).

If the other computer responds to your question then the list of Reply times will appear.

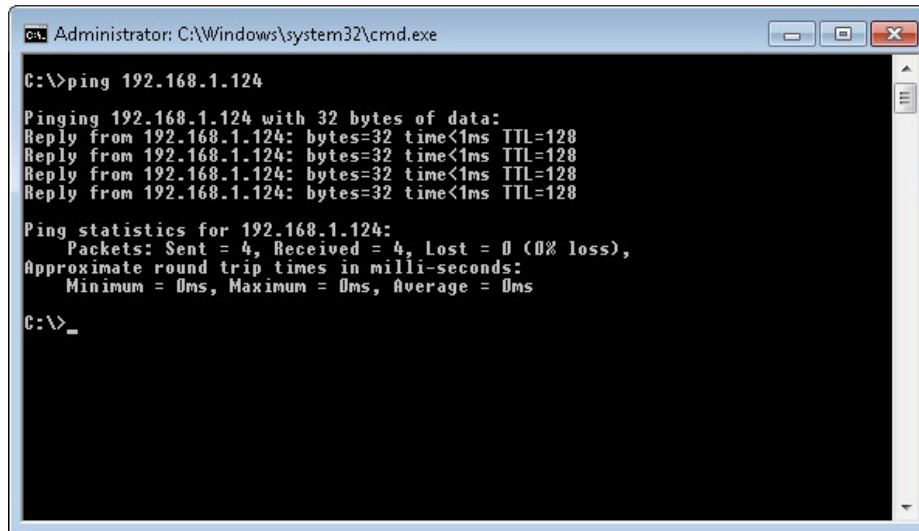

```
Administrator: C:\Windows\system32\cmd.exe
C:\>ping 192.168.1.124
Pinging 192.168.1.124 with 32 bytes of data:
Reply from 192.168.1.124: bytes=32 time<1ms TTL=128
Reply from 192.168.1.124: bytes=32 time<1ms TTL=128
Reply from 192.168.1.124: bytes=32 time<1ms TTL=128
Reply from 192.168.1.124: bytes=32 time<1ms TTL=128
Ping statistics for 192.168.1.124:
    Packets: Sent = 4, Received = 4, Lost = 0 (0% loss),
    Approximate round trip times in milli-seconds:
        Minimum = 0ms, Maximum = 0ms, Average = 0ms
C:\>_
```

In case of unsuccessful connection, you will see "Request time out" or "Destination host unreachable".

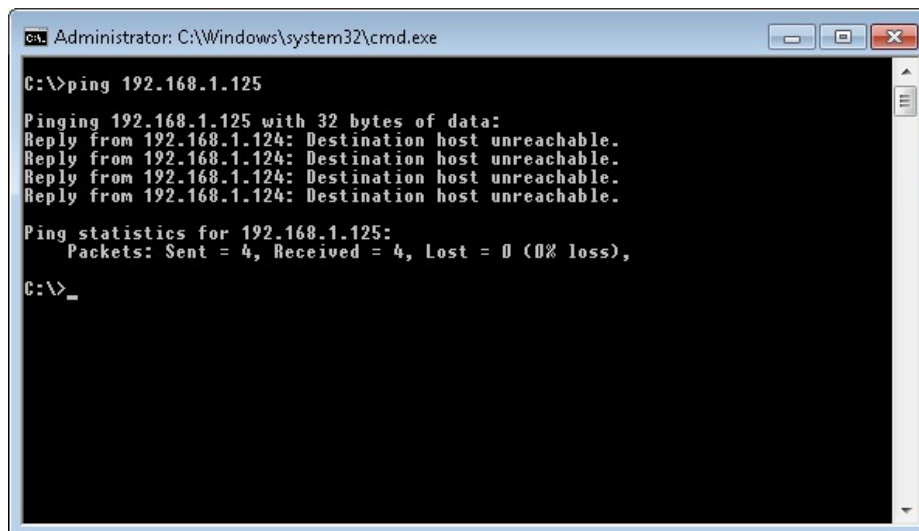

```
Administrator: C:\Windows\system32\cmd.exe
C:\>ping 192.168.1.125
Pinging 192.168.1.125 with 32 bytes of data:
Reply from 192.168.1.124: Destination host unreachable.
Reply from 192.168.1.124: Destination host unreachable.
Reply from 192.168.1.124: Destination host unreachable.
Reply from 192.168.1.124: Destination host unreachable.
Ping statistics for 192.168.1.125:
    Packets: Sent = 4, Received = 4, Lost = 0 (0% loss),
C:\>_
```

If you did not establish a connection with another computers, make sure the computers are physically connected by a network cable (via switch), and if the cable is not damaged. Furthermore, make sure that required IP address of the other computers are correct. If you still fail, contact the IT department.

## **Server software installation (the same for the A3800)**

### **Database system (MySQL)**

It is a software which is in charge of measured data saving.

### **Data Manager**

It is a software which collects measured data from A3716 units and sends them to database system. Data Manager is a part of DDS and is launched on the server only.

### **DDS**

Is a software designed to analyze measured data and it also controls and set the online readings.

### **Meas Engine**

It is a software in each A3716 measurement unit. Performs specified measurements and provides readings to *Data Manager* software.

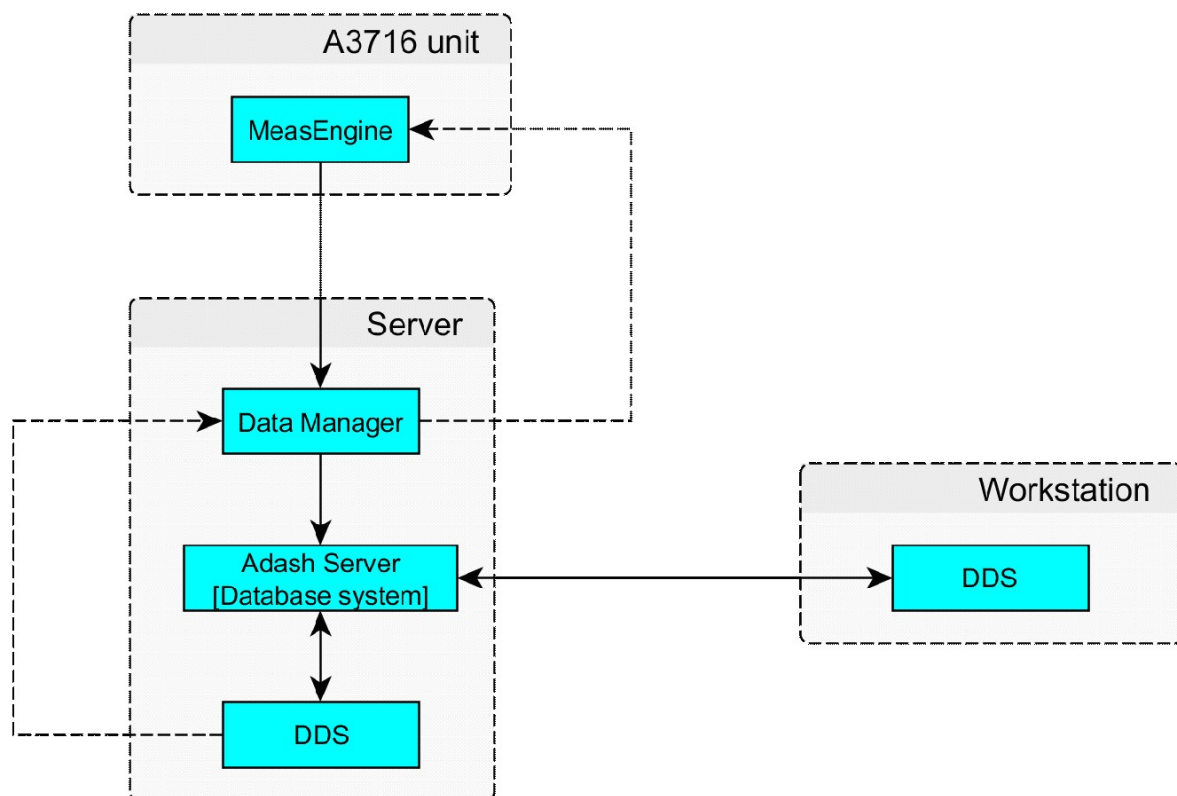

Once you will install the Adash server, you can also install DDS on the server and on remaining user computers. The installation is identical on all components and the installation wizard will guide you through the entire process. After completing of all DDS the installation, you can proceed to create a project and start collecting data.

The DDS installation is described in DDS user guide.

## Adash Server installation

Run the **Adash\_Server\_vx.x.x.exe** . This file you can download from Adash website or it is supplied on USB flash drive which came with your A3716.



Press Next on the welcome screen.

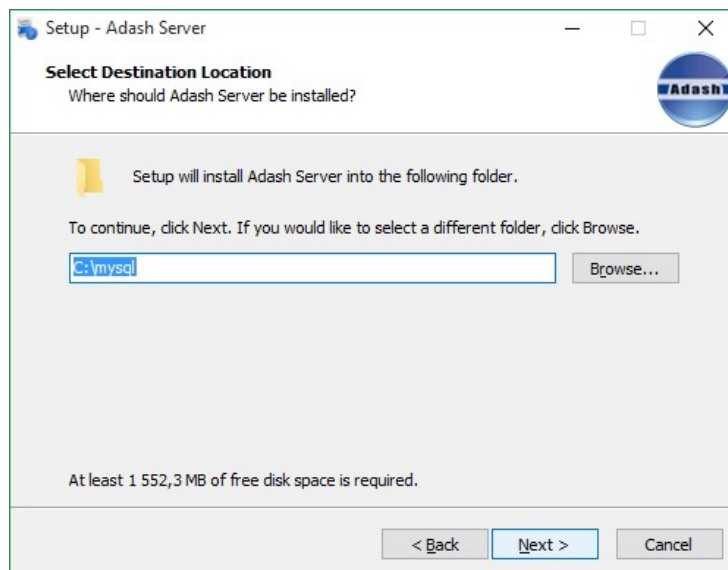

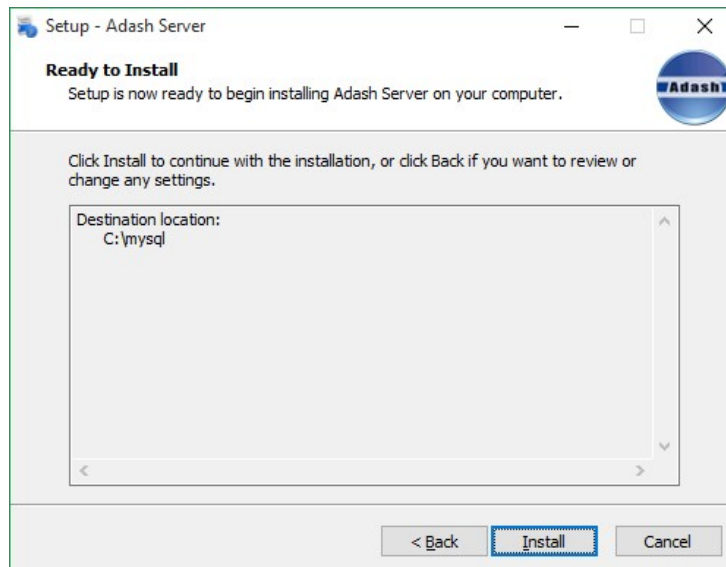

Press Install.

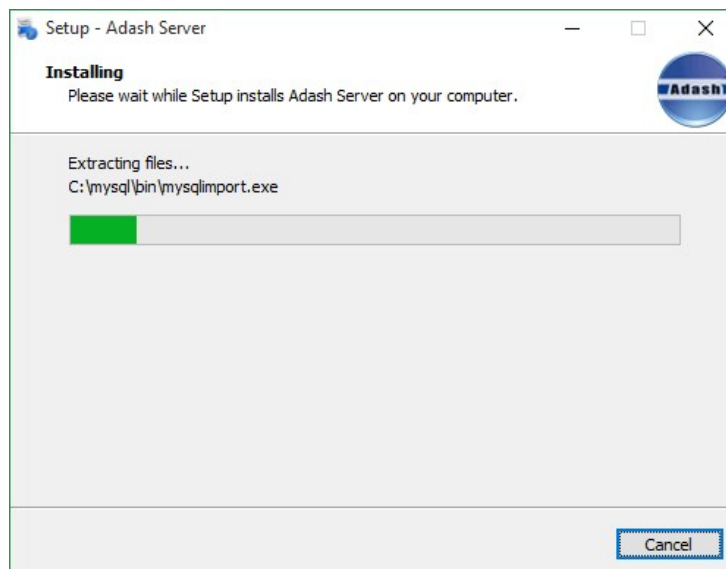



In the optional part of installation you can install *MySQL ODBC connector* and *MySQL Workbench*. *MySQL ODBC connector* is a database driver that is required by DDS. If you have it already installed from other sources, then you do not need to install it now.

*MySQL Workbench* is a database manager. It is not necessary to install this software for standard using of DDS.

## **DDS – online database and collecting of readings (the same for the A3800)**

Install the DDS software on a server. We recommend to use DDS installed on the server (it means the computer with Adash\_Server software).

### **Online database creation**

Press *New* in the Tree tab (small down arrow) and select *Online* item. The new window with database parameters appears. Enter the DDS database name and SQL server database name for (small characters, without space and special characters are recommended), IP address or name of the computer (server where you installed Adash\_server), enter "adash" as user name and "adash" as a password. Confirm by OK and new empty online database will be created.

**Remark:** In case you installed the Adash\_server on your local PC, type **localhost** into the Server item. Not recommended!

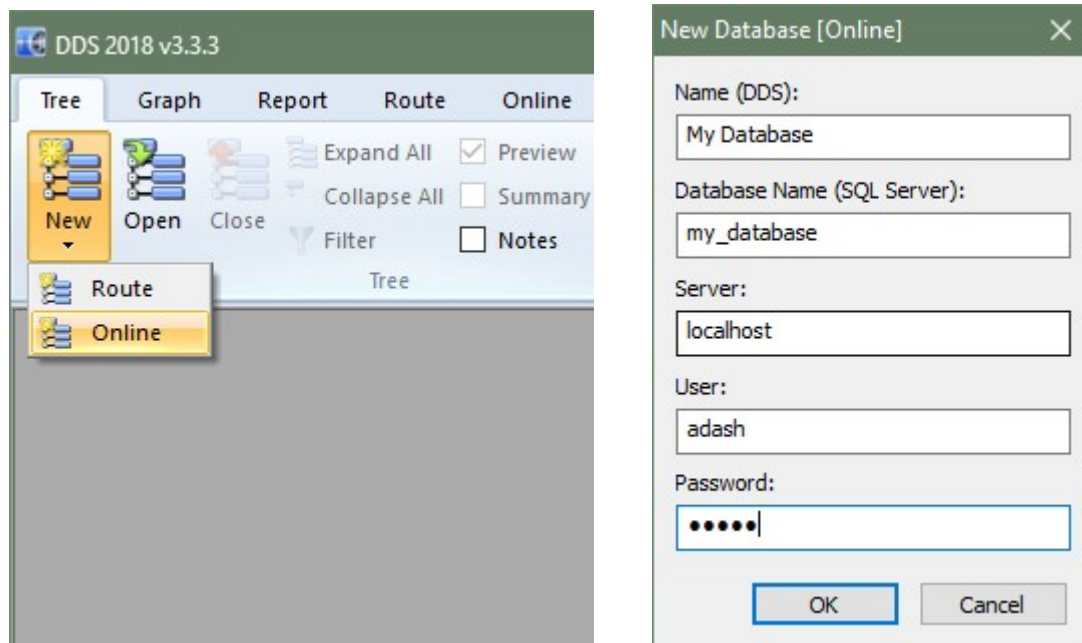

Now you should create required database (tree) structure. The following hierarchy has to be done *Machine → Point → Data Cells*.

See *DDS* manual about how to create the tree structure. All data cells in the tree will be used for online readings.

If you have not installed the MySQL connector odbc (part of Adash server, see previous chapter), then the Online item is not displayed.

Microsoft SQL Server can be also used for data.base. Set the Global Setting/ General/ Other/ Allow MS SQL to yes.

### **Measuring unit and database connection**

After measurement point creation you have to assign the A3716 unit.

## List of A3716 (A3800) units

Select *Online* tab. Press *A3716 Units* button. New window with A3716 units list appears. Press *Add*. Enter IP address or network name of the new unit (usually A3716-xxxxxx, where x is unit serial number), internal unit name (e.g. Fans 1.floor) and text description if necessary. If MPX unit is available check the "MPX" button (this will allow tree to use 64 channels). Check the *Use* item. The new unit appears in the list of units. Its actual network status is displayed (*Connect / Disconnect*). Check the LAN network when the unit is not available (server  $\leftrightarrow$  a3716). Use the *Refresh* button to obtain the new status. It can take a while. Button *Analyze* checks DDS setup and displays a list of measurements that will be sent into selected unit.

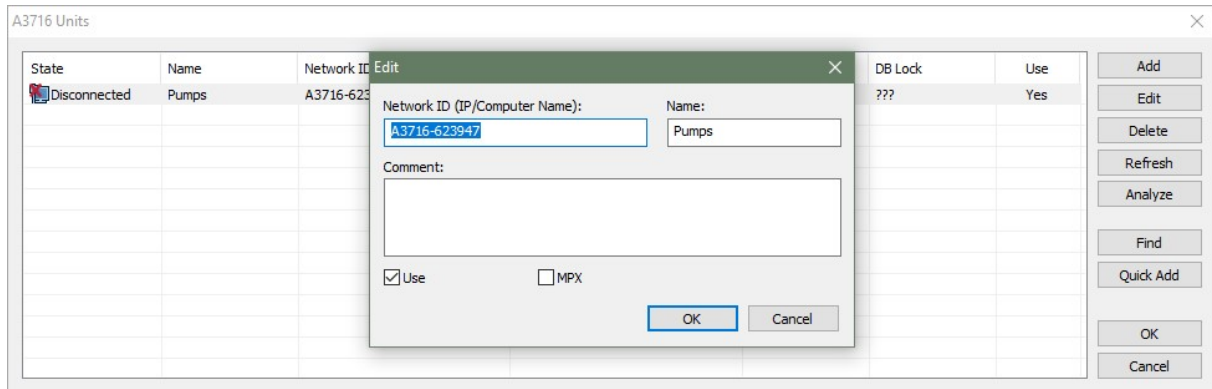

## Assigning the unit and channel to point

Open the *Properties* window of selected point (press right mouse button on the point and select *Properties*). Select the first tab (1D, 2D or 3D). Select required *Online unit* and *Channel* number.

If the data cells are already defined, then the tree structure is ready to be send to A3716 unit and to start the readings collection.

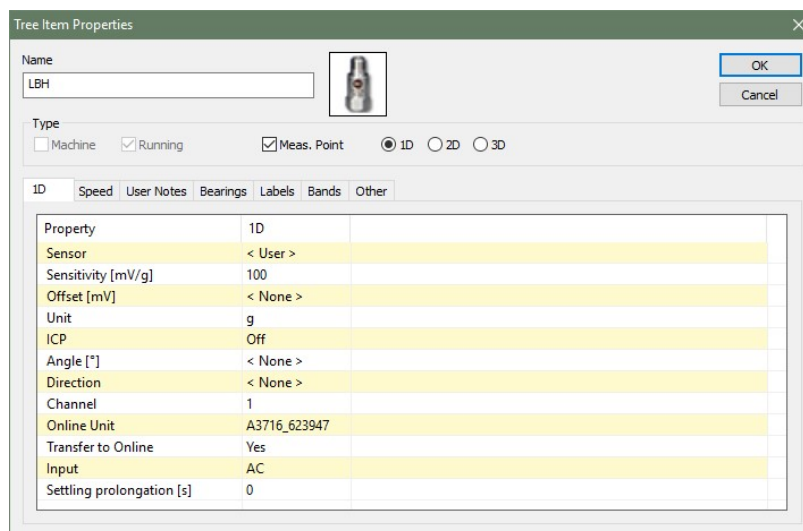

## Start of the data collection

Use the *Start* or *Stop* buttons in *Data collection* section in *Online* tab.

After pressing *Start* the data collection is started. The software is registered as service (registered with the name *AdashDM\_NameDB*). In case of computer reset it starts again automatically.

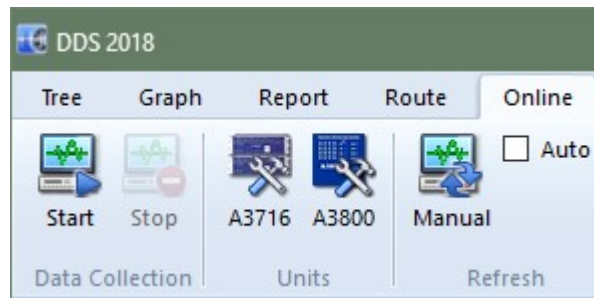

The readings will not appear immediately after you start the data collection. The data download is arranged in batches of many readings. The interval between downloads is set in the Global settings in the *Online* tab, *Data Transfer* item. Do not use short interval (less 60 sec), the server may be overloaded.

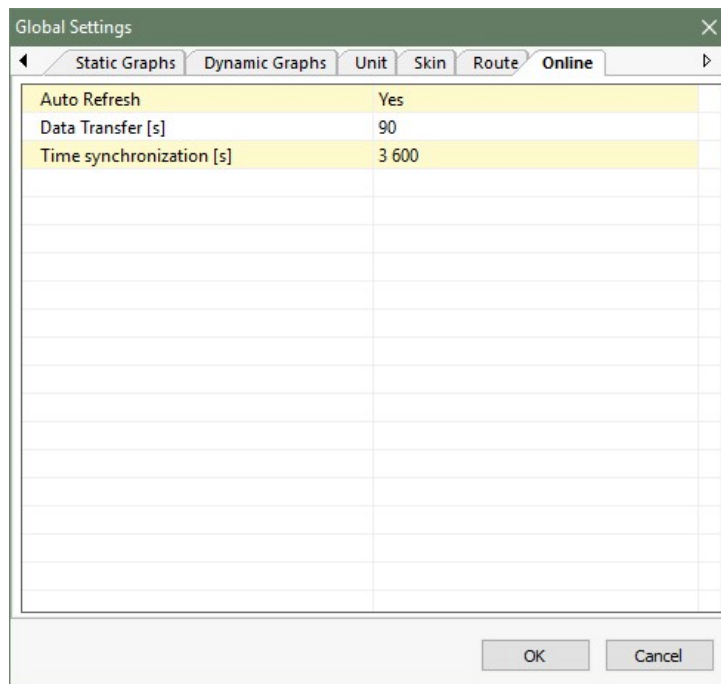

### **Graph refresh time interval**

The graphs are refreshed manually (*Manual* button) or automatically (check the *Auto* box).

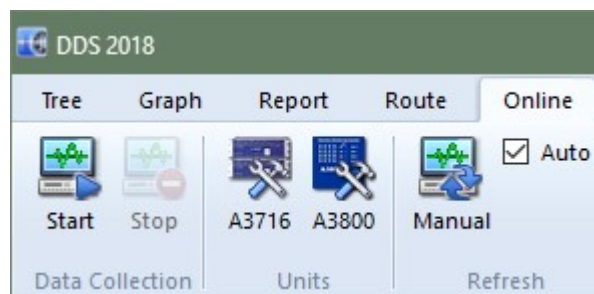

Refresh interval is edited in the global settings in the *Online* tab. Use *Auto Refresh Interval*. Remember that graph refresh does not make any new reading. Refresh makes new reading from the database only

## Actual data reading

DDS enables to read the actual measurement anytime. The static readings are available only. Select required items (points) in the Tree and check the **View Actual** box in **Data** section.

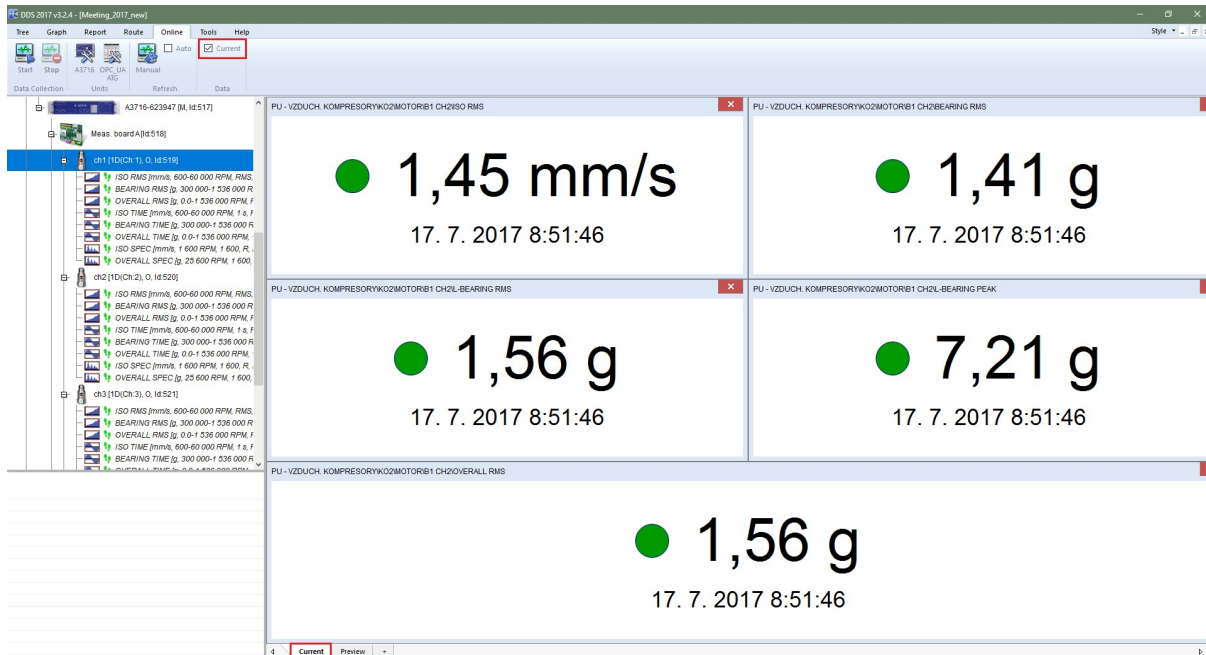

## Current loops and relays

Current loops and relays can be set only for static measurements. Its settings is situated in Online tab, in Properties of data cell window.

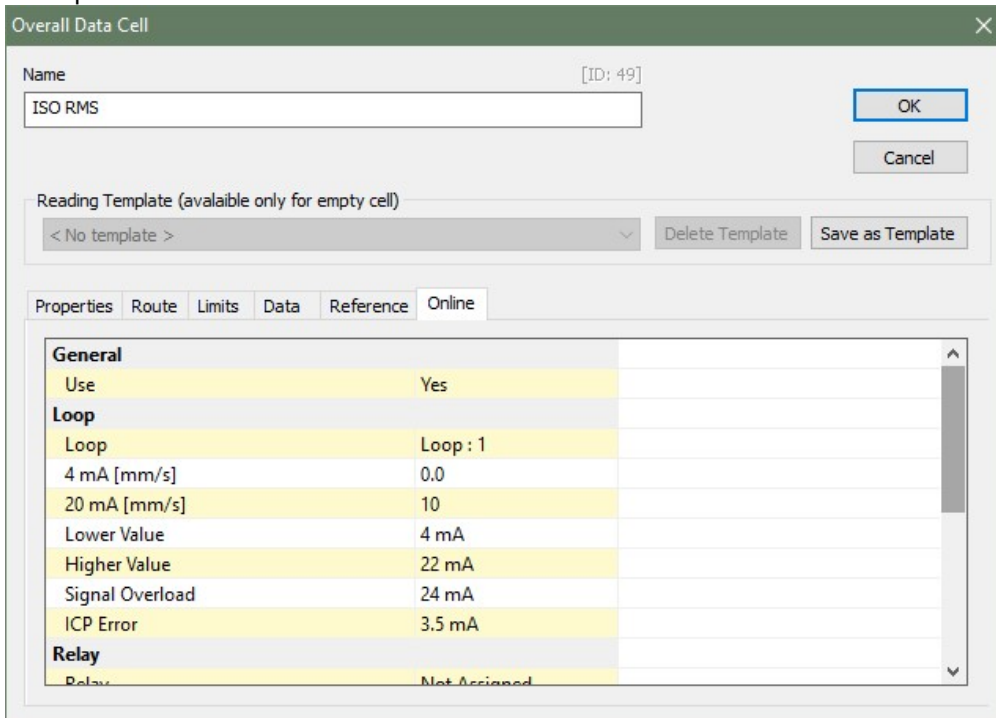

## Conditional measurements

The Adash allows to set up a conditional measurement of the controlled data cell by the value of the controlling data cell. For example: When the Order analysis data cell is set that its controlling data cell (ID parameter of controlling data cell) is speed data cell and valid interval is 2500-3500 RPM (Min and Max parameters), then the measurement of order analysis will be take only in this interval. Data saving is then controlled by Adaptive algorithm (see Adaptive algorithm chapter).

The ID parameter of target data cell then indicates that all data of the data cell will be stored into data cell with specified ID.

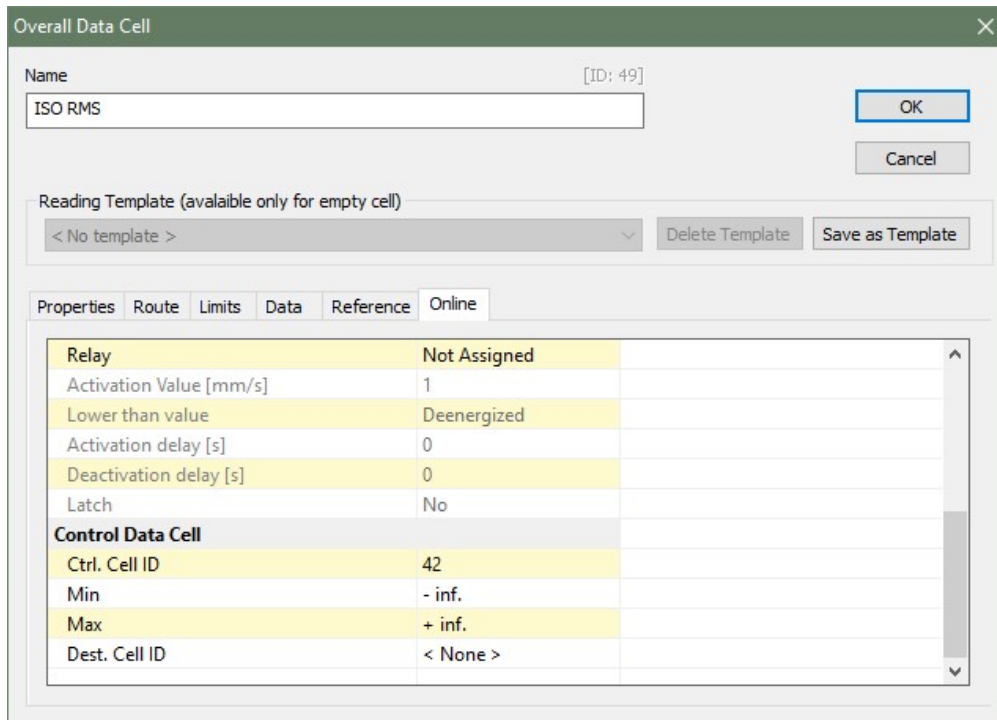

Relay	Not Assigned
Activation Value [mm/s]	1
Lower than value	Deenergized
Activation delay [s]	0
Deactivation delay [s]	0
Latch	No
<b>Control Data Cell</b>	
Ctrl. Cell ID	42
Min	- inf.
Max	+ inf.
Dest. Cell ID	< None >

## Temporary stop of readings

You can simply stop readings for whole A3716 unit or for one point (it means one channel) or for one data cell.

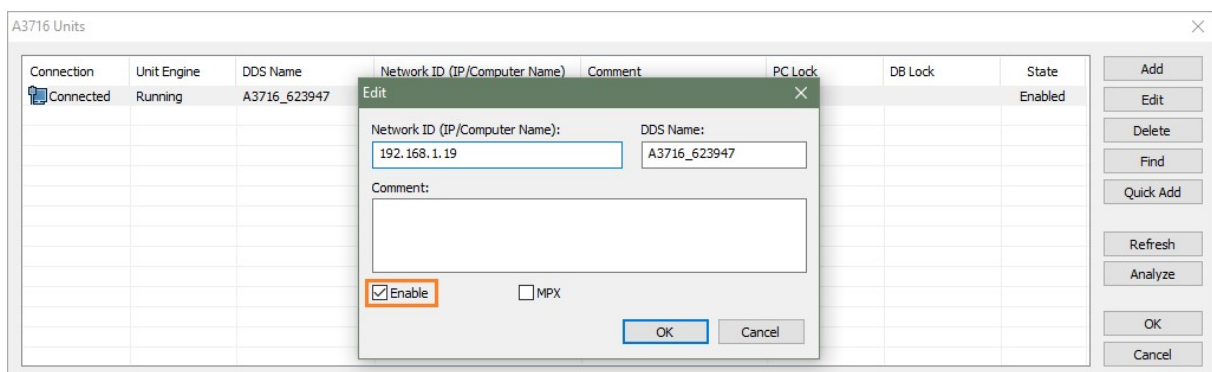

Connection	Unit Engine	DDS Name	Network ID (IP/Computer Name)	Comment	PC Lock	DB Lock	State
Connected	Running	A3716_623947	192.168.1.19				Enabled

Push the A3716 Units button. Select the A 3716 unit. Push Edit button. Uncheck the *Enable* box and push OK. All readings made by this unit will be stopped. When you check back the Enable box then the readings will be taken again.

If you need to disable (temporarily) all measurements in measurement point, you can simply do it. Open the properties of selected point and set the **Transfer to Online** to **No**. It is available for all point dimensions (1D/2D/3D).

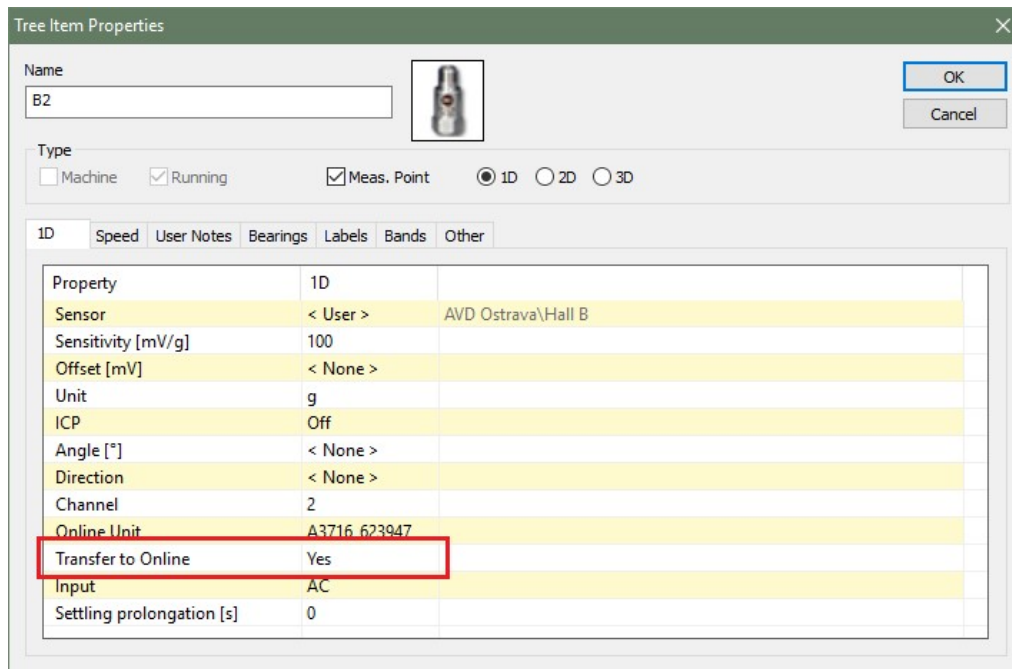

To disable one measurement, open properties of selected data cell, go to Online tab and set the **Use** to **No**.

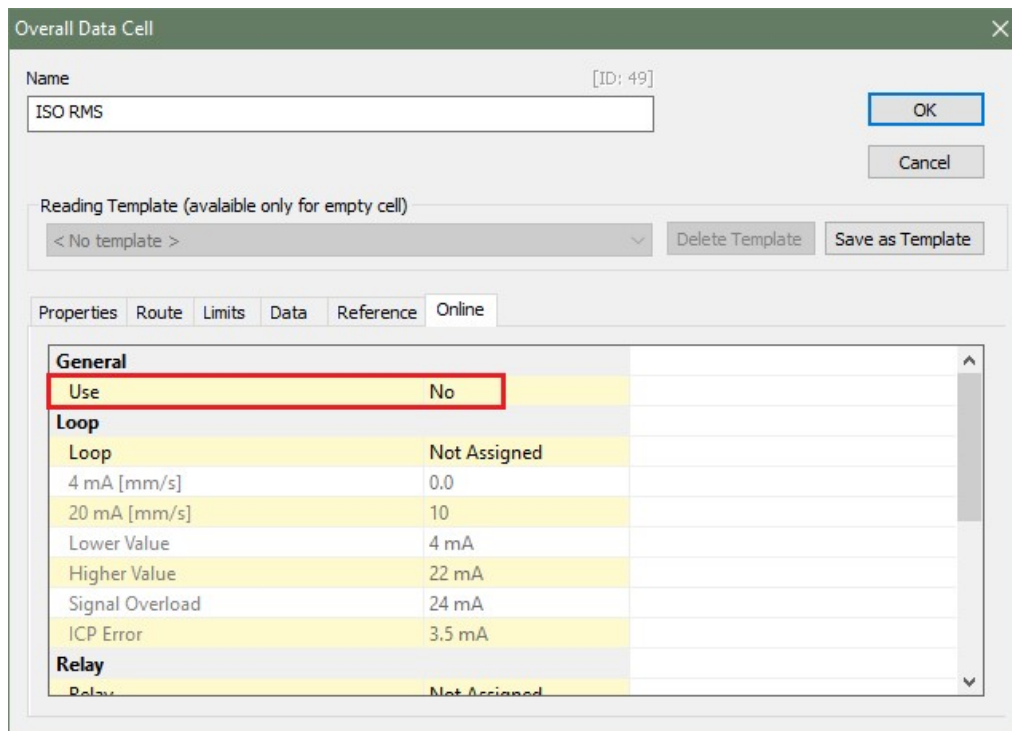

### Advanced functions for A3716 (A3800) units

There are the set of advanced functions for A3716 unit. Use the right mouse click above selected A3716 unit (in management dialog *Online/Units/A3716*).

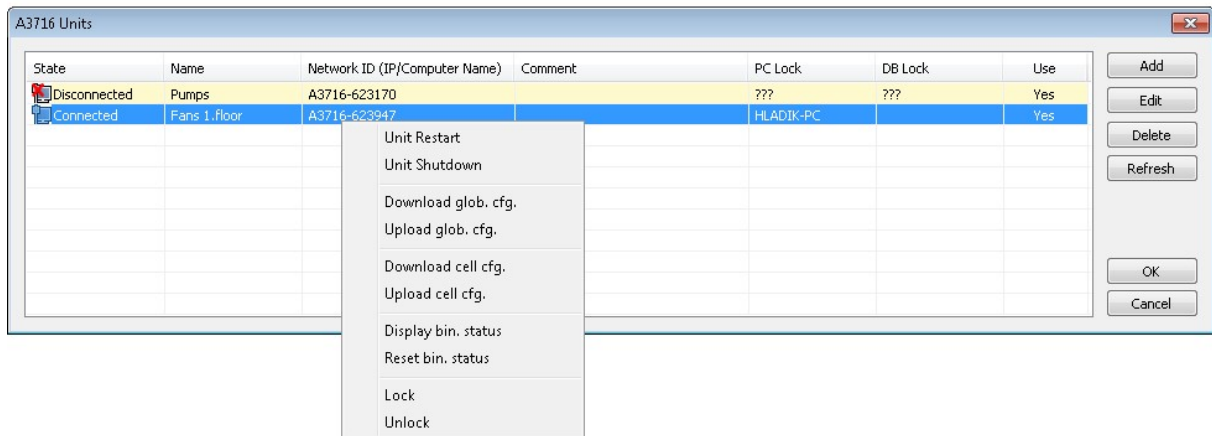

**Unit Restart** –remotely restarts the A3716 unit (refresh of status).

**Unit Shutdown** - remotely switches off the A3716 unit.

**Download glob. cfg** – downloads the configuration file with default setting of adaptive algorithm

**Upload glob. cfg** – upload the configuration file with default setting of adaptive algorithm

**Download Cell cfg.**– download the data cell configuration file with current setting of adaptive algorithm

**Upload Cell cfg.**– upload the data cell configuration with new setting of adaptive algorithm

**Display bin. status** - display current status of parameters of adaptive algorithm

**Reset bin. status** – reset parameters of adaptive algorithm

**Lock** – lock the unit A3716 only for your computer

**Unlock** – unlock the unit A3716 for everybody

## **A3716 (A3800) lock**

As the units A3716 are accessible to all users in network, the more users can use the unit at the same time. To avoid this situation we use the functions Lock/Unlock. When you use the Lock function, your computer and database is registered in the A3716 unit as the only one computer which can have access to online data collection. The other users cannot change the configuration in the unit.

The Lock function of the unit is used automatically when data collection is started.

The Lock or Unlock can be done manually (Advanced function).

## **Updating DDS**

DDS can't be updated while is data collection running. If you need to update DDS, please always Stop data collection first with older DDS version, then update DDS and Start data collection again.



## **Adaptive algorithm for readings**

The A3716 can take readings (setting using the DDS) completely different way than other systems.

Let's explain it on example. In the past the time interval between readings must have been defined. E.g. if 1 minute was defined, then the reading was triggered every minute. The time length of reading was e.g. 1 second. If the change in vibration level occurred during this minute, it was not captured.

The new adaptive system measures continuously. If one reading length is one second, then new reading is taken every second. You can not miss any change in vibration level.

If all these readings would be continuously stored, then the size of the database would enormously grow. Hard drive size would be filled very quickly and the access to the database would be very slow. That is not allowable.

Therefore the adaptive algorithm was developed. This software is installed in each A3716 unit. It controls, which reading will be saved to database and which will not. The basic rule is that it is not necessary to store the reading that is the same as the previous one.

### **How does the algorithm work?**

We will demonstrate the algorithm function now. We want to measure the static value (overall value). Each reading is checked whether it is valid ( ICP error, overload). The invalid reading is removed.

When the system runs for the first time the first reading is always saved.

The capture of local extremes follows. Let's suppose that last values are 3.5 and 3.8 mm/s. It is the increasing trend (3.8 is higher than 3.5). We want to capture local extremes. If next reading is 3.1mm/s then the 3.8 is the local extreme and it is saved to database.

The basic function of the algorithm is to save significantly different readings. Significant change is evaluated on the basis of two relative limit levels (e.g. 5%) and absolute (0.1 mm/s). If the value of the current measurement differs from the last stored by more than 5% and also more than 0.1 mm/s, then it is the significant change and the reading is saved. The reasonable amount of readings should be saved. If the vibrations are oscillating, then the relative limit level is increased. When the vibrations again becomes stable, then the level is decreased. The special procedure is used for runup and coast down.

The next thing algorithm is checking is time interval between last saved reading and current. If this interval exceed the allowed value, then the current reading is saved. Even if there is no significant change.

### **Large dynamic readings processing**

When the user defines large dynamic readings (too many lines or samples) then the readings are saved only when the time interval between expired defined value.

### **Data saving example**

Next graphs contains examples of trend with various relative limit levels. The first graph contains full data and next are taken with 5%, 10%, 20% and 50% relative limit level. As you can see, no information is lost.

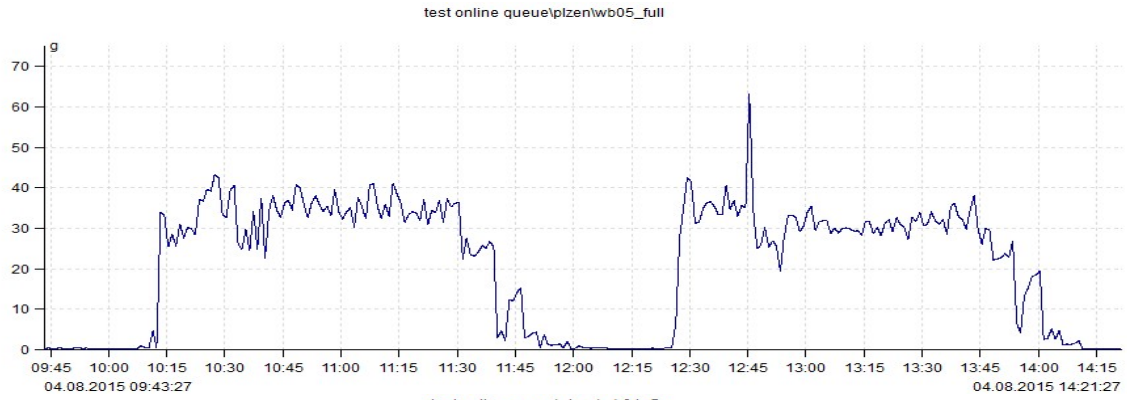

## Variable settings of data collection

All control parameters are saved in A3716 unit in file **c:\A3716\data\online.cfg**. The factory setting uses the adaptive algorithm, but you can use also user modified collection control. It is strictly recommended to create backup copy of file before modification. Please, modify only the items, which you fully understand.

You can modify this file via DDS. In A3716 units list use right-click and **Download online.cfg**. You save it and you can edit it by Notepad. Use the **Upload online.cfg** to send it back to A3716 unit.

New parameters are applied after the project is restarted ( or A3716 unit is restarted).

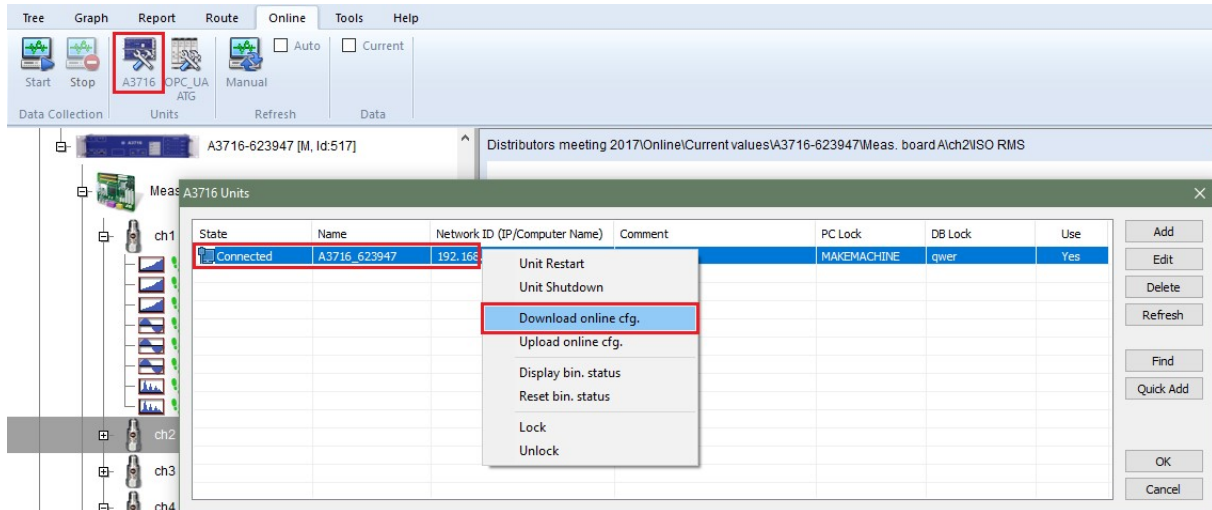

## **Regulator section**

Find the section [Regulator] and modify parameters.

### **all readings**

0 = adaptive algorithm or time interval savings is used for data storing (dilution).

1 = all data will be saved to database (only for limited time recommended, the disc can be full filed very quickly)

### **adaptive**

0 = adaptive algorithm is disabled

1 = adaptive algorithm is enabled

### **short dynamic max samples**

the maximum samples number, which is allowed for adaptive algorithm on dynamic measurements (called short dynamics). Longer measurements are saved only in **long dynamics interval save**

### **statics interval save**

the number of seconds

if the adaptive algorithm is used, then it is the max time interval between saved static measurements

if the time interval saving is used, then it is the time interval between every saved static measurements

### **short dynamics interval save**

the number of seconds

the same meaning as previous item, but used for short dynamic measurements

### **long dynamics interval save**

the number of seconds  
the time interval between every saved long dynamic measurements, remember that adaptive algorithm is never used for long dynamics

## **Examples**

### ***To save all data***

**all readings=1**

Note: All readings (measurements) will be saved (according to measurement length). Beware that this option can fill the hard drive very quickly.

### ***To save data only in defined intervals***

**all readings=0**

**adaptive=0**

**statics interval save=60**

**short dynamics interval save=180**

**long dynamics interval save=3600**

Note: Adaptive algorithm is disabled. Static readings (measurements) will be saved every minute, short dynamics every 3 minutes and long dynamics every hour.

### ***Use adaptive algorithm***

**all readings=0**

**adaptive =1**

**statics interval save=21600**

**short dynamics interval save=21600**

**long dynamics interval save=21600**

Note: Adaptive algorithm is enabled. Static values, short dynamics and long dynamics are saved every 6 hours if there is no change according to adaptive algorithm.

## **Time synchronization of A3716 (A3800)**

It is important to keep internal time of all A3716 units up to date. In the beginning set the correct time zone in A3716. The **Data\_Manager** synchronizes time in all A3716 units with the time on Adash server. The interval of synchronization is in **DDS/ Online tab/ Time synchronization**.

## **A3716 (A3800) Update**

This chapter is appointed for advanced users only.

- 1) Connect a keyboard, a mouse and a monitor to your A3716 device (or you can use remote desktop connection).
- 2) Login as user remote (password remote).
- 3) Copy A3716\_ver02##.exe file anywhere to A3716 (eg. folder C:). Use usb flash drive or network to copy it.
- 4) Run it.
- 5) A3716 Setup Wizard will open.
- 6) Choose the language of instalation and follow the Wizzard's instructions.